

User's Guide

CFETF10xx-110

Slide-in-Module Media Converter

- **Fast Ethernet™**
- **Copper to Fiber**
- **100Base-TX to 100Base-FX**

Transition Networks CFETF10xx-110 series Fast Ethernet™ 100Base-TX to 100Base-FX media converters (*designed to be installed in a PointSystem™ chassis*) connect 100Base-TX twisted-pair copper cable to multimode or single mode 100Base-FX fiber-optic cable.

Part Number	Port One - Copper 100Base-TX	Port Two - Fiber-Optic 100Base-FX
CFETF1011-110	RJ-45 100 m (328 ft)*	ST, 1310 nm multimode 2 km (1.2 miles)*
CFETF1013-110	RJ-45 100 m (328 ft)*	SC, 1310 nm multimode 2 km (1.2 miles)*
CFETF1014-110	RJ-45 100 m (328 ft)*	SC, 1310 nm single mode 20 km (12.4 miles)*
CFETF1015-110	RJ-45 100 m (328 ft)*	SC, 1310 nm single mode 50 km (24.9 miles)*
CFETF1016-110	RJ-45 100 m (328 ft)*	SC, 1310 nm single mode 60 km (32.3 miles)*
CFETF1017-110	RJ-45 100 m (328 ft)*	SC, 1550 nm single mode 80 km (49.7 miles)*
CFETF1040-110**	RJ-45 100 m (328 ft)*	Empty SFP Slot

*Typical maximum cable distance. Actual distance is dependent upon the physical characteristics of the network installation.

**CFETF1040-110 supports 100Base-FX Modules only.

Installation	2
Operation	5
Cable Specifications	7
Technical Specifications	9
Troubleshooting	10
Contact Us	11
Compliance Information	12

Installation

CAUTION: Wear a grounding device and observe electrostatic discharge precautions when setting the 4-position switch and the jumper and when installing the slide-in-module media converter. Failure to observe this caution could result in damage to, and subsequent failure of, the media converter.

Set the 4-Position Switch

- The 4-position switch is located on the circuit board.
- Use a small flat-blade screwdriver or a similar device to set the recessed switches (see the drawing to the right).

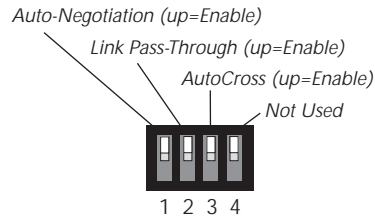

- Auto-Negotiation™**
 up Advertises 100 Mb/s full-duplex and half-duplex (only during Auto-Negotiation). (See page 5.)
 down Disable Auto-Negotiation.
- Link Pass-Through**
 up Enable Link Pass-Through. (See page 6.)
 down Disable Link Pass-Through.
- AutoCross™**
 up Enable AutoCross™ - The media converter connects automatically to either straight-through or crossover twisted-pair copper cable. (See page 5.)
 down Disable AutoCross™ - Either straight-through or crossover twisted-pair copper cable must be installed, according to the site requirements.
- (not used)

Set the Hardware/Software Jumper

The hardware/software jumper is located on the media converter circuit board. Use small needle-nosed pliers or a similar device to set the jumper. Refer to the drawings below when setting the media converter for hardware or software mode.

Hardware The media converter mode is determined by the 4-position switch settings listed above.

Software The media converter mode is determined by the most-recently saved, on-board microprocessor settings.

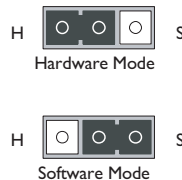

Installation -- Continued

Install the Slide-In-Module

CAUTION: Wear a grounding device and observe electrostatic discharge precautions when installing the CFETF10xx-110 slide-in-module media converter. Failure to observe this caution could result in damage to, and subsequent failure of, the media converter.

- Carefully slide the slide-in-module into the installation slot, aligning the module with the installation guides.
- Ensure that the module is firmly seated inside the chassis.
- Push in and rotate the attached panel fastener screw clockwise to secure the module to the chassis front.

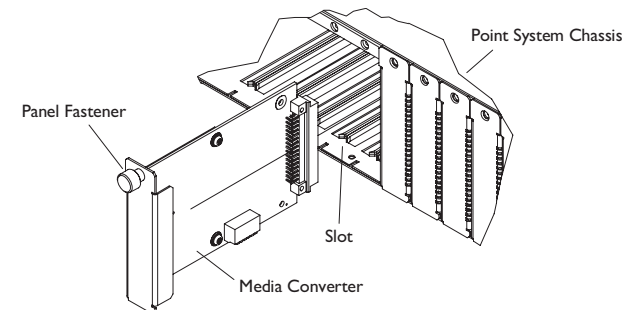

Connect the Twisted-Pair Copper Cable

- Locate or build 100Base-TX compliant cables, with male RJ-45 connectors installed at both ends.
- Connect the RJ-45 connector at one end of the cable to the RJ-45 port on the CFETF10xx-110 media converter.
- Connect the RJ-45 connector at the other end of the cable to the RJ-45 port on the other device (switch, workstation, etc.).

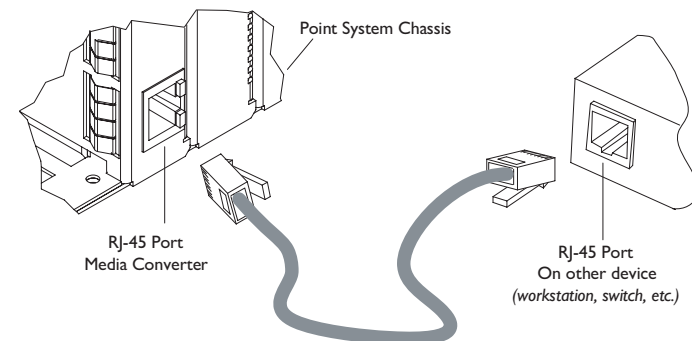

Installation -- Continued

Connect the Fiber Cable

1. Locate or build 100Base-FX compliant fiber cable with male, two-stranded TX to RX connectors installed at both ends.
2. Connect the fiber cables to the CFETF10xx-110 media converter as described:
 - Connect the male TX cable connector to the female TX port.
 - Connect the male RX cable connector to the female RX port.
3. Connect the fiber cables to the other device (*another media converter, hub, etc.*) as described:
 - Connect the male TX cable connector to the female RX port.
 - Connect the male RX cable connector to the female TX port.

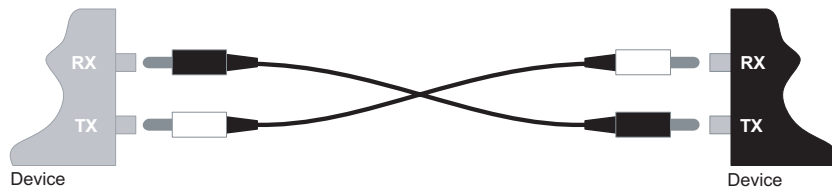

Power the Media Converter

The slide-in-module media converter is powered through the Transition Networks *PointSystem™* chassis.

Operation

Status LEDs

The CFETF10xx-110 media converter is designed to operate without user intervention. Use the status LEDs to monitor the media converter operation in the network.

PWR	On =	Connection to external AC power.
FX	On =	A link has been established for the fiber connection.
	Flashing =	The fiber connection is receiving data.
TX	On =	A link has been established for the copper connection.
	Flashing =	The copper connection is receiving data.

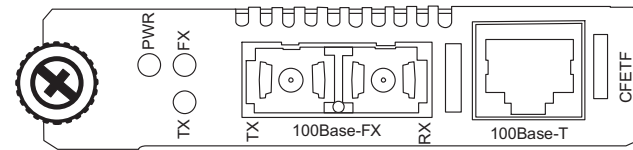

Product Features

Auto-Negotiation™

The Auto-Negotiation feature allows the CFETF10xx-110 media converter to automatically configure itself to achieve the best possible mode of operation over a link. The media converter broadcasts its speed (*100 Mb/s*) and duplex capabilities (*full or half*) to the other devices and negotiates the best mode of operation. Auto-Negotiation allows quick and easy installation because the optimal link is established automatically. No user intervention is required to determine the best mode of operation.

A scenario where the media converter is linked to a non-negotiating device is a case where the user may want to disable Auto-Negotiation. In this instance, the mode of operation will drop to the least common denominator between the two devices (*e.g. 100 Mb/s, half-duplex*). Disabling this feature gives the user the ability to force the connection to the desired speed and duplex mode of operation.

AutoCross™

When the AutoCross feature is activated, it allows either straight-through (MDI) or crossover (MDI-X) copper cables to be used when connecting to 100Base-TX devices. AutoCross determines the characteristics of the connection and automatically configures the unit to link up, regardless if the copper cable is MDI or MDI-X configuration.

Note: Factory default is “enable AutoCross.” Transition networks recommends leaving the device in the “enable” mode.

Operation -- Continued

Link Pass-Through

When the Link Pass-Through feature is activated (*see page 2*), the media converter monitors both the fiber and copper RX (*receive*) ports for loss of signal. In the event of a loss of an RX signal (1), the media converter will automatically disable the TX (transmit) signal (2), thus, “passing through” the link loss (3). The far-end device is automatically notified of the link loss (4), which prevents the loss of valuable data unknowingly transmitted over an invalid link.

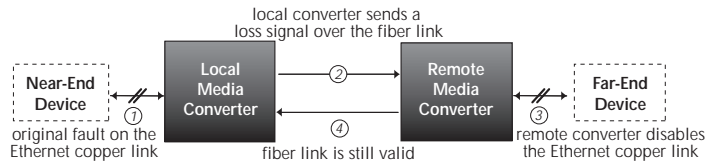

Full-Duplex Network

In a full-duplex network, maximum cable lengths are determined by the type of cables that are used. See page 1 (*front cover*) for the cable specifications for the different CFETF10xx-110 models.

The 512-Bit Rule does not apply in a full-duplex network.

Half-Duplex Network (512-Bit Rule)

In a half-duplex network, the maximum cable lengths are determined by the round trip delay limitations of each Fast Ethernet™ collision domain. (*A collision domain is the longest path between any two terminal devices, e.g. a terminal, switch, or router.*)

The 512-Bit Rule determines the maximum length of cable permitted by calculating the round-trip delay in bit-times (BT) of a particular collision domain. If the result is less than or equal to 512 BT, the path is good.

For more information on the 512-Bit Rule, see the white paper titled “Collision Domains” on the Transition Networks website at: www.transition.com.

Operation -- Continued

SNMP

See the on-line documentation that comes with Transition Networks *FocalPoint™* software for applicable commands and usage.

Use SNMP at an attached terminal or at a remote location to monitor the media converter by monitoring:

- Media converter power
- Copper link and fiber link status
- Hardware switch settings
- Fault condition

Also, use SNMP to enter network commands that:

- Enable/disable full-/ half-duplex
- Enable/disable Link Pass-Through (LPT)
- Power down the media converter

Cable Specifications

Copper Cable

Category 5:

Gauge	24 to 22 AWG
Attenuation	22.0 dB /100m @ 100 MHz
Maximum Cable Distance	100 meters

- Straight-through (MDI) or crossover (MDI-X) twisted-pair cable may be used.
- Shielded (STP) or unshielded (UTP) twisted-pair cable may be used.
- Pins 1&2 and 3&6 are the two active pairs in an Ethernet™ network .
- Use only dedicated wire pairs for the active pins:
(*e.g., blue/white & white/blue, orange/white & white/orange, etc.*)
- Do not use flat or silver satin wire.

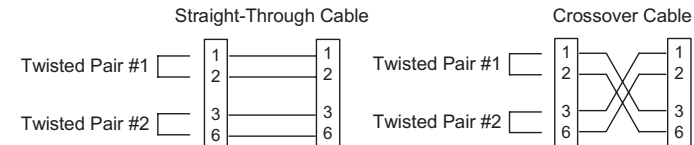

Fiber Cable

The physical characteristics must meet or exceed IEEE 802.3™ specifications.

Bit Error Rate:	<10 ⁻⁹
Single mode fiber (recommended):	9 μm
Multimode fiber (recommended):	62.5/125 μm
Multimode fiber (optional):	100/140, 85/140, 50/125 μm

Cable Specifications -- Continued

CFETF1011-110	1310 nm multimode		
Fiber Optic Transmitter Power:	min: -19.0 dBm	max: -14.0 dBm	
Fiber Optic Receiver Sensitivity:	min: -30.0 dBm	max: -14.0 dBm	
Link Budget:	11.0 dB		
CFETF1013-110	1310 nm multimode		
Fiber Optic Transmitter Power:	min: -19.0 dBm	max: -14.0 dBm	
Fiber-optic Receiver Sensitivity:	min: -30.0 dBm	max: -14.0 dBm	
Link Budget:	11.0 dB		
CFETF1014-110	1310 nm single mode		
Fiber-optic Transmitter Power:	min: -15.0 dBm	max: -8.0 dBm	
Fiber-optic Receiver Sensitivity:	min: -31.0 dBm	max: -8.0 dBm	
Link Budget:	16.0 dB		
CFETF1015-110	1310 nm single mode		
Fiber-optic Transmitter Power:	min: -5.0 dBm	max: -2.0 dBm	
Fiber-optic Receiver Sensitivity:	min: -34.0 dBm	max: -7.0 dBm	
Link Budget:	29.0 dB		
CFETF1016-110	1310 nm single mode		
Fiber-optic Transmitter Power:	min: -5.0 dBm	max: 0.0 dBm	
Fiber-optic Receiver Sensitivity:	min: -34.0 dBm	max: -7.0 dBm	
Link Budget:	29.0 dB		
CFETF1017-110	1550 nm single mode		
Fiber-optic Transmitter Power:	min: -5.0 dBm	max: 0.0 dBm	
Fiber-optic Receiver Sensitivity:	min: -34.0 dBm	max: -7.0 dBm	
Link Budget:	29.0 dB		

The fiber optic transmitters on this device meet Class I Laser safety requirements per IEC-825/CDRH standards and comply with 21 CFR1040.10 and 21CFR1040.11.

Technical Specifications

For use with Transition Networks Model CFETF10xx-110 or equivalent.

Product is certified by the manufacturer to comply with DHHS Rule 21/CFR, Subchapter J applicable at the date of manufacture.

Standards	IEEE 802.3™
Data Rate	100 Mb/s
Dimensions	3.4" x 5.0" x 0.87" (86 x 182 x 22 mm)
Weight	3 oz (91 g) (approximate)
Power Consumption	3.5 watts, 200 mA @ 13.9 VDC
MTBF**	406,000 hours (MIL217F2 V5.0) (MIL-HDBK-217F) 1,593,000 hours (Bellcore7 V5.0)
Environment	Tmra*: 0 to 60°C (32 to 140°F) Storage Temp: -20 to 85°C (-4 to 185°F) Humidity: 5 to 95%, non condensing Altitude: 0 to 10,000 feet
Warranty	Lifetime

*Manufacturer's rated ambient temperature: Tmra range for this slide-in-module depends on the physical characteristics and the installation configuration of the Transition Networks PointSystem™ chassis in which this slide-in-module will be installed.

**MTBF is estimated using the predictability method. This method is based on MIL-217F and Bellcore standards at 40°C ambient temperature, typical enclosure heat rise of 10°C, and nominal operating conditions and parameters. Installation and configuration specific MTBF estimates are available upon request. Contact Technical Support.

Product is certified by the manufacturer to comply with DHHS Rule 21/CFR, Subchapter J applicable at the date of manufacture.

CAUTION: Visible and invisible laser radiation when open. Do not stare into the beam or view directly with optical instruments.

CAUTION: Use of controls, adjustments or the performance of procedures other than those specified herein may result in hazardous radiation exposure.

CAUTION: Copper based media ports, e.g., Twisted Pair (TP) Ethernet, USB, RS232, RS422, RS485, DS1, DS3, Video Coax, etc., are intended to be connected to intra-building (inside plant) link segments that are not subject to lightning transients or power faults. Copper based media ports, e.g., Twisted Pair (TP) Ethernet, USB, RS232, RS422, RS485, DS1, DS3, Video Coax, etc., are NOT to be connected to inter-building (outside plant) link segments that are subject to lightning transients or power faults.

The information in this user's guide is subject to change. For the most up-to-date information on the CFETF10xx-110 media converter, view the user's guide on-line at: www.transition.com.

Troubleshooting

If the media converter fails, isolate and correct the failure by determining the answers to the following questions and then taking the indicated action:

1. Is the PWR LED illuminated?
 - NO
 - Is the media converter slide-in-module installed properly in the chassis?
 - Is the power cord properly installed in the chassis and at the external power source?
 - Does the external power source provide power?
 - Contact Technical Support: 1-800-260-1312 (*Int'l: 00-1-952-7600*).
 - YES
 - Proceed to step 2.
2. Is the TX LED illuminated?
 - NO
 - Check the twisted-pair cables for proper connection.
 - Contact Technical Support: 1-800-260-1312 (*Int'l: 00-1-952-7600*).
 - YES
 - Proceed to step 3.
3. Is the FX LED illuminated?
 - NO
 - Check the fiber cables for proper connection.
 - Verify that the TX and RX cables on the media converter are connected to the RX and TX ports, respectively, on the other device.
 - Contact Technical Support: 1-800-260-1312 (*Int'l: 00-1-952-7600*).
 - YES
 - Proceed to step 4.
4. Is the TX LED flashing?
 - NO
 - If there is no activity on the 100Base-TX port, proceed to step 5.
 - If there is activity on the 100Base-TX port, disconnect and reconnect the 100Base-TX cable to restart the initialization process.
 - Restart the workstation to restart the initialization process.
 - Contact Technical Support: 1-800-260-1312 (*Int'l: 00-1-952-7600*).
 - YES
 - Proceed to step 5.
5. Is the FX LED flashing?
 - NO
 - If there is no activity on the 100Base-FX port, continue below
 - If there is activity on the 100Base-FX port, disconnect and reconnect the 100Base-FX cable to restart the initialization process.
 - Verify that the TX and RX cables on the media converter are connected to the RX and TX ports, respectively, on the other device.
 - Restart the workstation to restart the initialization process.
 - Contact Technical Support: 1-800-260-1312 (*Int'l: 00-1-952-7600*).
 - YES
 - Contact Technical Support: 1-800-260-1312 (*Int'l: 00-1-952-7600*).

Contact Us

Technical Support

Technical support is available 24 hours a day.
 US and Canada: 1-800-260-1312
 International: 00-1-952-941-7600

Transition Now

Chat live via the Web with Transition Networks Technical Support.
 Log onto www.transition.com and click the Transition Now link.

Web-Based Seminars

Transition Networks provides seminars via live web-based training.
 Log onto www.transition.com and click the Learning Center link.

E-Mail

Ask a question anytime by sending an e-mail to our technical support staff.
techsupport@transition.com

Address

Transition Networks
 10900 Red Circle Drive
 Minnetonka MN 55343, U.S.A.
 telephone: 952-941-7600
 toll free: 800-526-9267
 fax: 952-941-2322

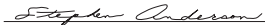
		Declaration of Conformity	
Name of Mfg:	Transition Networks 10900 Red Circle Drive, Minnetonka MN 55343, U.S.A.		
Model:	CFETF10xx-110 Series media converters		
Part Number(s):	CFETF101-110, CFETF1013-110, CFETF1014-110, CFETF1015-110, CFETF1016-110, CFETF1017-110, CFETF1040-110		
Regulation:	EMC Directive 89/336/EEC		
Purpose:	To declare that the CFETF10xx-110 to which this declaration refers is in conformity with the following standards.		
	CISPR 22:1993; EN 55022:1994+A1: 1995+A2:1997, Class A; EN 55024:1998; FCC Part 15 Subpart B; EN 61000-3-2:1995+A14:2000; EN 61000-3-3: 199521 CFR subpart J		
	I, the undersigned, hereby declare that the equipment specified above conforms to the above Directive(s) and Standard(s).		
	 Stephen Anderson, Vice-President of Engineering	January, 2009 Date	

Compliance Information

CISPR22/EN55022 Class A + EN55024

CE Mark

FCC Regulations

This equipment has been tested and found to comply with the limits for a Class A digital device, pursuant to part 15 of the FCC rules. These limits are designed to provide reasonable protection against harmful interference when the equipment is operated in a commercial environment. This equipment generates, uses, and can radiate radio frequency energy and, if not installed and used in accordance with the instruction manual, may cause harmful interference to radio communications. Operation of this equipment in a residential area is likely to cause harmful interference, in which case the user will be required to correct the interference at the user's own expense.

Canadian Regulations

This digital apparatus does not exceed the Class A limits for radio noise for digital apparatus set out on the radio interference regulations of the Canadian Department of Communications.
Le présent appareil numérique n'émet pas de bruits radioélectriques dépassant les limites applicables aux appareils numériques de la Class A prescrites dans le Règlement sur le brouillage radioélectrique édicté par le ministère des Communications du Canada.

European Regulations

Warning This is a Class A product. In a domestic environment this product may cause radio interference in which case the user may be required to take adequate measures.

Achtung! Dieses ist ein Gerät der Funkstörgrenzwertklasse A. In Wohnbereichen können bei Betrieb dieses Gerätes Rundfunkstörungen auftreten. In diesem Fall ist der Benutzer für Gegenmaßnahmen verantwortlich.

Attention! Ceci est un produit de Classe A. Dans un environnement domestique, ce produit risque de créer des interférences radioélectriques, il appartiendra alors à l'utilisateur de prendre les mesures spécifiques appropriées.



In accordance with European Union Directive 2002/96/EC of the European Parliament and of the Council of 27 January 2003, Transition Networks will accept post usage returns of this product for proper disposal. The contact information for this activity can be found in the 'Contact Us' portion of this document.



CAUTION: RJ connectors are NOT INTENDED FOR CONNECTION TO THE PUBLIC TELEPHONE NETWORK. Failure to observe this caution could result in damage to the public telephone network.

Der Anschluss dieses Gerätes an ein öffentliches Telekommunikationsnetz in den EG-Mitgliedstaaten verstösst gegen die jeweiligen einzelstaatlichen Gesetze zur Anwendung der Richtlinie 91/263/EWG zur Angleichung der Rechtsvorschriften der Mitgliedstaaten über Telekommunikationsendeinrichtungen einschliesslich der gegenseitigen Anerkennung ihrer Konformität.

Trademark Notice

All trademarks and registered trademarks are the property of their respective owners.

Copyright Restrictions

© 2001, 2003, 2005 Transition Networks.

All rights reserved. No part of this work may be reproduced or used in any form or by any means - graphic, electronic, or mechanical - without written permission from Transition Networks.

Printed in the U.S.A.